

Catalogo Termostato ATEX

Termostati ATEX con bulbo e capillare	2
Limitatore di sicurezza positivo per atmosfere potenzialmente esplosive	3
Sonda rivestita Pt100 con alloggiamento "d"	4
Sonda PT100 certificata ambiente ATEX	5
Termostati ATEX con elevata capacità di interruzione	6
Termostato d'ambiente ATEX	7
Termostato d'ambiente ATEX G + D	8
Termostati ATEX con bulbo e capillare	9



M.C.A. sas Via Madonna 57, 20021 Bollate (MI)

Tel: 02- 3512774

Mail: mca@mcastrumenti.it

Web: www.mcastrumenti.it

CAC-EX

ATEX Thermostats with Bulb and Capillary *Termostati ATEX con bulbo e capillare*

- Thermostats with ATEX II 2 G - Ex d II C T6 certified microswitch for use in hazardous areas
- IP65 epoxy protected aluminium enclosure
- Adjustable set point when voltage is on after cover removing
- Supplied with cable 3m long, protected by flexible stainless steel sleeve (internal connection is not allowed). End of this cable has to be connected on link cable out of the hazardous area, or inside a Ex e or Ex d certified terminal box

- *Termostati con microinterruttore certificato ATEX II 2 G - Ex d II C T6 per l'uso in atmosfere potenzialmente esplosive*
- Resina epossidica con rivestimento in alluminio IP65
- Setpoint interno indicizzabile attivato dopo l'apertura del coperchio
- Uscita cavo diretta Lg 3m protetta da guaina metallica flessibile (collegamento interno non ammesso). Estremità del cavo da collegare all'esterno della zona o in una scatola ausiliaria certificata Ex e o Ex d

Reference <i>Référence</i>	Range <i>Plage</i>	Differential <i>Différentiel</i>	Ts mini.	Ts maxi.	Tb mini.	Tb maxi.	Tm mini.	Tm maxi.	Contact <i>Contact</i>	Bulb <i>Bulbe</i>	Capillary <i>Capillaire</i>	Weight <i>Poids</i>
CAC050-EX	0 to 50°C	2°C	-70	125	-20	40	-15	70	(SPDT / INV) 5A / 250VAC 3A / 30VDC	copper / cuivre Ø6,5 Lg150mm	copper / cuivre Lg1,5m	1,5 kg
CAC150-EX	10 to 150°C	3°C	-70	125	- 5	40	- 5	170		s. steel / inox Ø4,7 Lg 92mm	s. steel / inox Lg1,5m	1,5 kg
CAC300-EX	50 to 300°C	5°C	-70	125	0	40	- 0	320		s. steel / inox Ø4 Lg100mm	s. steel / inox Lg1,5m	1,5 kg

Also available ranges / *sur demande plages*: -25 +25 / 0-25 / 0-70 / 20-90 / 80-200 / 10-450 / 60-500 / 180-600 / 280-700°C

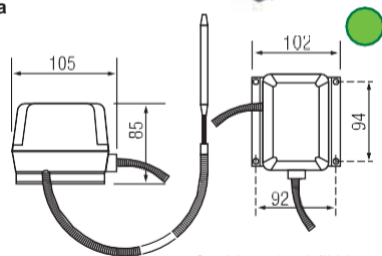

C = blue wire / *fil bleu*
NO = white wire / *blanc*
NC = red wire / *fil rouge*

LJS-EX

Fail Safe Temperature Limiter for Hazardous Area

Limitatore di sicurezza positivo per atmosfere potenzialmente esplosive

- **ATEX II 2 G+D - Ex ed II C T6 certified temperature cutout for hazardous areas (dust and gas)**
- **For temperature limitation on constant power heat tracing or on industrial equipment in hazardous areas**
- **Fail safe cutout**
- **IP65 polyester terminal box**
- **Manual reset**
- **2m lgth capillary with metal flexible sleeve**
- **Limitatori certificati ATEX II 2G + D - Ex ed II C T6 per l'uso in atmosfere esplosive (gas e polveri)**
- **Per la limitazione della temperatura su traccianti elettrici a potenza costante o apparecchiature di processo di grandi dimensioni**
- **Sicurezza positiva che garantisce l'apertura del contatto in caso di deterioramento del sistema di misurazione**
- **Custodia in poliestere antiurto IP65 con viti di chiusura sigillabili**
- **Ripristino manuale dopo la rimozione del cofano**
- **Regolazione del set point con un cacciavite dopo aver rimosso il coperchio**
- **Capillare Lg 2m protetto da guaina metallica flessibile**

Reference Référence	Range Plage	Differential Différentiel	Ts mini.	Ts maxi.	Tb mini.	Tb maxi.	Tm mini.	Tm maxi.	Contact Contact	Bulb Bulbe	Capillary Capillaire	Weight Poids(kg)
LJS120EX	40 - 120°C	4°C	-50	50	-10	40	-10	140	NF 10A/250VAC	copper / cuivre Ø6 Lg117mm	copper / cuivre Ø1,5 Lg 2m	0,12
LJS300EX	50 - 300°C	13°C	-50	50	-20	40	-30	345		St.Steel / inox Ø6 Lg 57mm	St.Steel / inox Ø1,5 Lg 2m	0,12

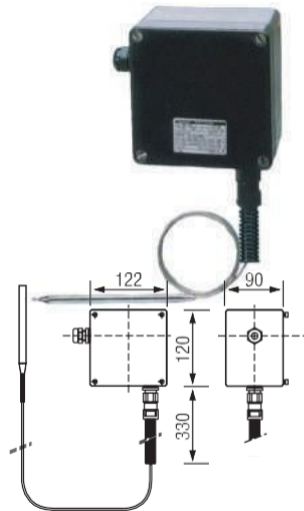

SPT / ATEX4445

ATEX Pt100 Sheathed Sensor with "D" Box *Sonda rivestita Pt100 con alloggiamento "d"*

- PT100 STANDARD element class B
- **ATEX EX II G/D - Ex d IIC T6 certified for GAS or DUST hazardous areas**
- Stainless steel AISI 316L flexible sheath Ø4,5 / 500mm long
- 1/2" BSP fixing under "d" aluminium box

Reference: SPT / ATEX - 4445L500

Option: 4-20mA Built-in transmitter
(specify the required temperature range)

- Elemento di misura NORMALIZZATO Pt100 classe B
- • Certificazione ATEX EX II G / D - Ex d IIC T6 per atmosfere esplosive GAS o DUST
- • Manicotto deformabile (estremità saf) in acciaio inossidabile AISI 316L Ø4,5 / Lg 500mm
- • Attacco 1/2 "G in contenitore di alluminio" tipo d ""

*Opzione: trasmettitore 4-20mA incorporato
(specificare l'intervallo di temperatura desiderato)*



Tm min.	Tm max.
-50°C	450°C

SPT/ATEX-2960

ATEX Certified Ambient Sensor *Sonda PT100 certificata ambiente ATEX*

- Ambient sensor with standardized PT100 class B element
- **ATEX Ex 2 G+D-Ex d IIC T6 certified for hazardous area gas or dust**
- Protection IP65

Option: Built-in transmitter (-50 to 50°C / 0 to 50°C / ou 0 to 100°C)

- *Sonde* • *Sensore ambiente standardizzato per elemento di classe PT100*
- *ATEX Ex 2 G + D-Ex certificato d IIC T6 gas esplosivo o atmosfera polverosa*

- *Protezione IP65*

Opzione: Trasmettitore integrato

(Da -50 a 50 ° C / da 0 a 50 ° C / o da 0 a 100 ° C)

Reference	Tm mini.	Tm max.
SPT/ATEX-2960	-50	80

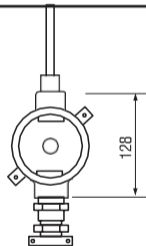

TAB-EX

ATEX Thermostat with High Amperage Rating *Termostati ATEX con elevata capacità di interruzione*

- **ATEX II 2 G - Ex d II C T6 / GGTN certified for hazardous area**
 - IP66 aluminium enclosure
 - Adjustable set point when supply is ON after side cap removing
 - SPDT contact 22A / 480Vac max for direct switching on single phase loads (radiators or heat tracing in hazardous areas)
- **Termostato certificato ATEX II 2G - Ex d II C T6 / GOSGORTECHNADZOR per l'uso in atmosfere potenzialmente esplosive**
 - **Alloggiamento in alluminio IP66**
 - **Indicizzazione in tensione dopo la rimozione di un opercolo laterale**
 - **Contatto max inverter 22A / 480Vac per lo spegnimento diretto di carichi monofase (radiatori di piccole dimensioni o tracce di zone esplosive))**

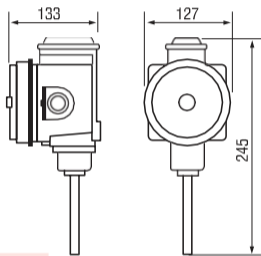

Reference <i>Référence</i>	Range <i>Plage</i>	Differential <i>Différentiel</i>	Ts mini.	Ts maxi.	Tb mini.	Tb maxi.	Rod <i>Canne</i>	Contact <i>Contact</i>	Weight <i>Poids</i>
TAB060 EX	-10 à +60°C	1,4°C	-40	+70	-40	+70	Ø 14,3 / Lg 70mm	(SPDT / INV) 22A/480VAC	1,6 kg

TAM-EX ATEX Ambient Thermostat

Termostato d'ambiente ATEX

- Ambient thermostat with ATEX II 2 G - Ex d II C T6 certified microswitch for use in hazardous areas
- IP65 epoxy protected aluminium enclosure
- Adjustable set point WHEN VOLTAGE IS ON, after window opening
- Supplied with cable 3m long, protected by flexible stainless steel sleeve (internal connection is not allowed). End of this cable has to be connected on link cable out of hazardous area, or inside an Ex e or Ex d certified terminal box
- Termostato ambiente con microinterruttore certificato ATEX II 2 G - Ex d II C T6 per l'uso in atmosfere potenzialmente esplosive
- Resina epossidica con rivestimento in alluminio IP65
- Setpoint interno indicizzabile UNDER TENSION dopo aver aperto l'oblò
- Uscita cavo diretta Lg 3m protetta da guaina metallica flessibile (collegamento interno non ammesso), da collegare all'esterno della zona o in un contenitore ausiliario certificato Ex e o Ex d

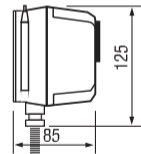
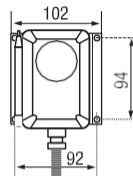

Reference Référence	Range Plage	Differential Différentiel	Ts mini.	Ts maxi.	Tb mini.	Tb maxi.	Contact Contact	Weight Poids(kg)
TAM050 EX	0 à +50°C	2°C	-70	+70	-40	+50	(SPDT/INV) 5A/250VAC 3A/ 30VDC	0,4

Variante: version sans hublot
Sur demande: plage 0 à 25°C

Version without window available
Alternative range 0 to 25°C

TAM-EXGD

ATEX G + D Ambient Thermostat *Termostato d'ambiente ATEX G + D*

- Ambient thermostat with ATEX Ex II 2 G+D - Ex ed IIC T6 / IP65 T80°C certified for hazardous areas GAS or DUST (zone 1 and 21)
- IP65 reinforced polyester enclosure with possible sealed screws
- Adjustable set point after cover opening
- SPDT contact 5A max / 230 VAC max
- Helicoïdal capillary under enclosure
- • *Termostato ambiente certificato ATEX Ex II 2G + D - Ex ed IIC T6 / IP65 T80 ° C per atmosfere potenzialmente esplosive Gas o polveri (zone 1 e 21)*
- • *Custodia in poliestere rinforzato con fibra di vetro IP65 con viti saldabili*
- • *Set point indicizzabile dopo la rimozione del coperchio*
- • *Contatto inverter max 5A / 230 V max*
- • *Capillare arrotolato sotto una scatola*

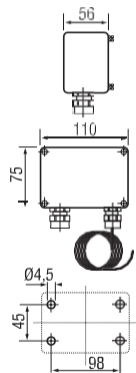

Reference <i>Référence</i>	Range <i>Plage</i>	Differential <i>Différentiel</i>	Ts mini.	Ts maxi.	Tb mini.	Tb maxi.	Contact <i>Contact</i>	Weight <i>Poids</i>
TAM050 EXGD	0 à +50°C	1,5°C	-50°C	+50°C	-20°C	+50°C	(SPDT/INV) 5A/230VAC	0,7kg

TCE-EX

ATEX Thermostats with Bulb and Capillary *Termostati ATEX con bulbo e capillare*

- **ATEX II 2 G - Ex d II C T6 / GOSGORTECHNADZOR certified thermostat for hazardous areas**
- IP66 aluminium enclosure
- Adjustable set point when supply is ON, after side cap removing
- SPDT contact 22A / 480VAC max for direct switching on single phase loads
- Can be used at very low ambient temperature (-40°C)

- **Termostato certificato ATEX II 2G - Ex d II C T6 / GOSGORTECHNADZOR per l'uso in atmosfere potenzialmente esplosive**
- **Alloggiamento in alluminio IP66**
- **Indicizzazione in tensione dopo la rimozione di un opercolo laterale**
- **Contatto max inverter da 22A / 480VAC per la commutazione diretta di carichi monofase**
- **Utilizzabile a temperatura ambiente molto bassa (-40 ° C)**



Reference <i>Référence</i>	Range <i>Plage</i>	Differential <i>Différentiel</i>	Ts mini.	Ts maxi.	Tb mini.	Tb maxi.	Tm mini.	Tm maxi.	Contact <i>Contact</i>	Bulb <i>Bulbe</i>	Capillary <i>Capillaire</i>	Weight <i>Poids</i>
TCE 160 EX	-5 to 163°C	4°C	-50	70	-40	70	-40	180	(SPDT / INV) 22A / 480VAC	s. steel / inox	s. steel / inox Lg 3m	1,6

